

QuickCounts\$

by Tipton Systems

...the fastest way to process large cash transactions with integration into ANY teller system.



- ✓ Speed up the customer transactions
- ✓ Improve cash counting accuracy
- ✓ Fewest rejects of good bills
- ✓ Advance counterfeit detection
- ✓ Compact design fits teller window
- ✓ NO software to install
- ✓ Completely stop manual entry of cash counts

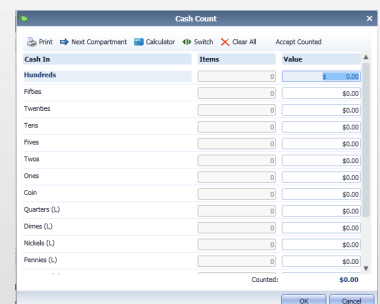
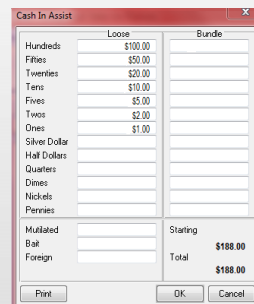
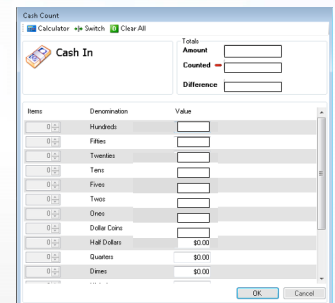

ZEUS *the next evolution*

Cassida Pro Series Zeus defines a new dawn in 2-pocket currency discriminators. With its unparalleled bill recognition, advanced counterfeit detection capabilities and detailed count reporting functions, Zeus packs amazingly strong features into a compact body.

Dual Clear and Start keys make Zeus ergonomically comfortable for both right and left handed users.

High definition LCD screen with user-configurable color settings.

Keyboard has hot keys for faster mode changes, less scrolling

2-pocket design means you never have to stop for a counterfeit, wrong denomination or incorrect face. Those bills go to the reject pocket while you continue counting.

Automated, patented dust shield lowers currency dust levels for users.

Count new or worn bills smoothly without jamming



Innovative technology



Dual-Side IR Scanning

Better security



Full Line UV Scanning

Fewest rejects

POWERED BY



Zeus uses high definition and full color infrared scanning on both sides of every bill to ensure unsurpassed denomination recognition and counterfeit detection.

Zeus uses full-line UV scanning, compared to conventional discriminators that use spot scanning.

Additional authentication by the proprietary Cassida M Algorithm, based on technical research of millions of circulating bills.

Zeus is user-centric

Modes and functions to speed through vault counts, end-of-day settlements, till set-ups, etc.



Use MIX mode to quickly count a stack of mixed denominations.

Usage: Verify merchant deposits, count larger transactions

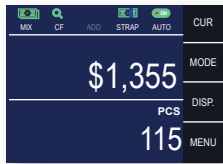

Total number and value of bills are displayed throughout count.

COUNT DETAIL			GT
1 \$	3	3	MODE
2 \$	0	0	MODE
5 \$	8	40	REPR
10 \$	50	500	REPR
20 \$	35	700	REPR
50 \$	3	150	REPR
100 \$	18	1,800	REPR
TOTAL			117 3,193 \$

Count detail screen shows value and count by denomination.



Use SORT mode to count and sort bills by one denomination.

Usage: Count incoming money shipments, conduct vault audits, buy and sell from vault

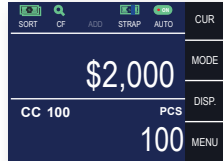

Screen shows count and pieces only of the sorted denomination.

REJECT DETAIL			GT
1	DIFF.		MODE
2	DIFF.		MODE
3	DIFF.		REPR
4	DIFF.		REPR
5	DIFF.		REPR
6	DIFF.		REPR
7	DIFF.		REPR
8	DIFF.		REPR
TOTAL			10 Rejects

Reject screen identifies reason for reject.



Sort bills by face up or down; or orient all bills in the same direction. Any bills that don't match the first bill through, regardless of denomination, are sent to the reject pocket.

Usage: Load ATM and tills, prepare for vault

Multiple strapping functions for real usability



Strap by number

Build bands or straps of bills for tellers, cashiers and vault. Zeus offers both pre-set and custom strap amounts: 100-50-25-20-10 presets, 1-100 adjustable.



Strap by amount

Eliminate hand sorting and counting for large customer withdrawals. Input the desired amount the customer wants, then count. Zeus automatically stops when it reaches the amount.



Strap by denomination

Set tills and drawers easily! Input count of each denomination needed. Zeus counts the specified number per denomination and sends all other bills to the reject pocket.

Usage: Ready cash for vault, conduct vault audits, set tills and cash drawers

More uptime, less downtime

Engineered for quiet reliability and lower maintenance

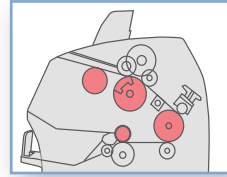

Zeus utilizes an innovative, patented motor drive system that eliminates multiple motors and drive rollers, resulting in a more efficient, quieter and lighter weight machine that has fewer serviceable parts.

Extremely quiet operation — speak easily and conduct business while Zeus runs quietly in the background.



Ergonomic design for easy use

Zeus was designed with you in mind. Its ultra-friendly interface lets you immediately become comfortable with modes, hot keys and counting functions. You'll get up to speed quickly... and so will your team. Expect exceptional productivity with minimal training, because Zeus streamlines productivity without being overly complicated.



The future of discriminators is here now... with Zeus



Zeus was developed to move cash discrimination forward. We envisioned a discriminator that would streamline cash processing; making it faster, easier and more accurate regardless of bill condition. The result is Zeus with its leading-edge bill recognition, unsurpassed counterfeit detection and minimalistic machine design -- driven by an extremely intuitive user interface. Try Zeus and you'll quickly know why it defines a new dawn in currency discrimination.

Cassida Pro Series: Advanced cash processing solutions

Cassida Pro Series products are innovative, featuring leading-edge technology to exceed the needs of demanding cash processing environments where durability and accuracy are the main requirements. As part of the Cassida Pro Series, the engineering, design, user interface and precision of the Zeus 2-pocket currency discriminator are backed by over a decade of service to global banks, financial institutions and larger retailers.

Cassida Pro Series Zeus sets the benchmark for processing cash in busy banks, credit unions, casinos and retailers. Zeus is the easiest-to-use, quietest, lowest weight, heavy duty 2-pocket discriminator on today's market.

Specifications:

Counting speed, mixed: ...800/1000/bill/min
Hopper capacity:.....500 bills
Reject capacity:100 bills
Stacker capacity:200 bills
Bill size range:120 x 60 to 180 x 90 mm
Interface:USB, RS-232, RJ-12, RJ-45
Detections:MG, full-line UV, double-sided
IR, high definition color CIS,
color spectrum analysis.
Power supply:.....100-240/50-60Hz
Weight:.....16.75 lbs (7.6 kg)

Features:

- Strapping by number of bills : 100-50-25-20-10 presets, 1-100 adjustable
- Strapping by amount
- Strapping by denomination
- Maintenance reminder (by date and by number of bills)
- Rear dust collector
- Adjustable reject and stacker capacity
- Self-update of software from a USB flash drive
- User-configurable screen color settings.
- Beep on/off
- Automatic, patented dust shield -- can be turned on or off
- Download reports to USB flash drive
- Optional remote display
- Optional PC connection software
- Optional printer

Dimensions:

Zeus is on average 40% smaller in total area than comparable bank grade discriminators on the market. That gives you 40% more work-space with Zeus.

Actual dimensions: 10.8" W x 9.8" D x 12" H (276*250*305 mm)

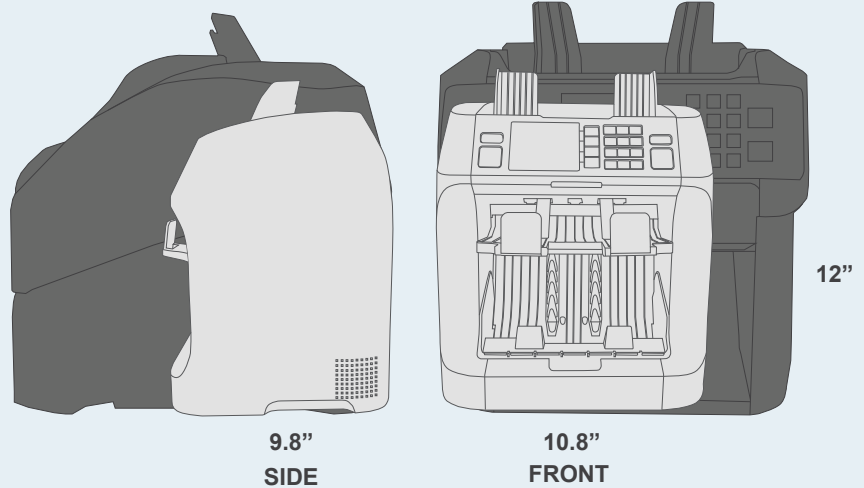

Cassida® **PRO**
SERIES

CassidaPro.com